

Prov. SPECIFICATION SHEET FOR ETHYLENE OXIDE SENSOR TYPE ETO/C-100

PERFORMANCE CHARACTERISTICS

Nominal Range	0 – 100 ppm
Maximum Overload	200 ppm
Expected Operation Life	2 years in air
Output Signal	200 ± 40 nA/ppm
Resolution	1 ppm
Temperature Range	- 40 °C to 50 °C
Pressure Range	Atmospheric
Pressure Coefficient	No data
T ₉₀ Response Time	< 140 sec
Relative Humidity Range	15 % to 90 % R.H. non-condensing
Typical Baseline Range (pure air, 20°C)	1 to 10 ppm equivalent
Maximum Zero Shift (+20°C to +40°C)	ND
Expected Long Term Output Drift	< 2 % signal loss/month
Recommended Load Resistor	10 Ohm
Bias Voltage	+ 300 mV
Repeatability	< 2 % of signal
Output Linearity	Linear

CROSS-SENSITIVITY DATA

Interfering Gas	Cross-Sensitivity (%)
CO	~ 40 %
Toluene	~ 20 %
Ethanol	~ 55 %

Performance data conditions:
20 °C, 50% RH and 1013 mbar

PHYSICAL CHARACTERISTICS

Weight	~ 13 g
Position Sensitivity	None
Storage Life	Six months in container
Recommended Storage Temperature	5 °C – 20 °C
Warranty Period	12 months from date of dispatch

Compact-Size Outline Dimensions

BOTTOM VIEW

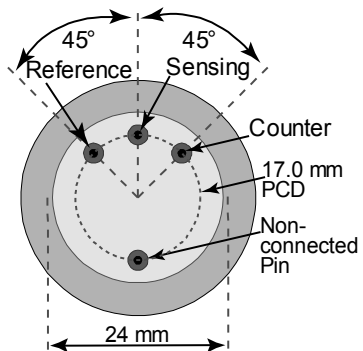

SIDE VIEW

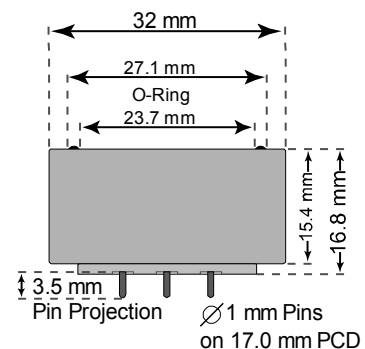

The data contained in this document is for guidance only. Membrapor AG accepts no liability for any consequential losses, injury or damage resulting from the use of this document or the information contained within it. The data is given for guidance only. Customers should test under their own conditions, to ensure that the sensors are suitable for their own requirements.

REV.: 12/2014

Page 1 of 1

Phone: +41 43 311 72 00
Fax : +41 43 311 72 01
Email: info@membrapor.ch
www.membrapor.ch

MEMBRAPOR AG
Birkenweg 2
CH-8304 Wallisellen
Switzerland